



HYUNDAI ELEVATOR CO., LTD.

HEAD OFFICE & FACTORY

San 136-1, Ami-ri, Bubal-eup, Icheon-si, Gyeonggi-do 467-734, Korea
 Tel: 82-2-3670-0661/0665 Fax: 82-2-3672-8763-4
 Homepage: <http://www.hyundaielevator.co.kr>
 E-mail: e-biz@hyundaielevator.co.kr

SEOUL OFFICE (INT'L SALES DIV.)

1-83 Dongsoong-dong, Jongno-gu, Seoul 110-510, Korea
 Tel: 82-2-3670-0661/0665 Fax: 82-2-3672-8763-4

INTERNATIONAL SALES & SERVICE NETWORK

ALGERIA

Flash Engineering & Trade
 03 Rue Saïdi Ahmed-Bordj El Kiffan Palace Center, Alger, Algeria
 Tel: 213-21-203785 Fax: 213-21-216444

BANGLADESH

Regional Traders Ltd.
 Karim Chamber(3rd Floor)99, Motijheel Commercial Area
 Dhaka-1000, Bangladesh
 Tel: 880-2-956-3122 Fax: 880-2-956-7377

CHINA

Shanghai Hyundai Elevator Manufacturing Co., Ltd.

• Head Office(Factory)

No.182, Zhenxi Nanlu Liantang Zhen, Qingpu-Qu,
 Shanghai 201716 China
 Tel: 86-21-5981-3981/3990/3961/3971
 Fax: 86-21-5981-3982

• Shanghai Office

Room 506, Yuan Zhong Scientific Research Bldg., No.1905
 Hongmei-Lu, Xuhui-Qu, Shanghai, 200233, China
 Tel: 86-21-6485-8600 Fax: 86-21-6485-3511/3512

EGYPT

International Eng. & Trade
 10 El Hakam St., Helmeyt El Zayton Cairo, Egypt
 Tel: 20-2-2241-8542 Fax: 20-2-2639-2672

INDIA

Kinetic Hyundai Elevator & Movement Technologies Ltd.
 G-92, D-III Block, Midc, Chinchwad, Pune-411 019 India
 Tel: 91-20-3950-2190/2191 Fax: 91-20-2747-0568

INDONESIA

PT. Superhelindo Jaya
 Jl. KH. Mochi Mansyur No 19B, Jakarta 10140, Indonesia
 Tel: 62-21-631-8444 Fax: 62-21-632-6288

IRAN

Mehfakhr. Flat No. 84 8th Flr. No. 23 Corner of 13th St.
 Asadabadi Ave. Tehran Iran
 Tel: 98-21-872-6082 Fax: 98-21-855-3741

IRAQ

Bemco Al-Arjoon Company For General Construction Ltd.
 Baghdad Karrada Salman Faiq Street
 Tar Al-Rasheed Building 3-D Floor
 Tel: 964-79-01-336499 Fax: 964-1-7196892

JORDAN

Bseiso Engineering Materials Corp.
 P. O. Box 830681 Amman 11183, Jordan
 Tel: 962-656-99012 Fax: 962-656-99014

KUWAIT

Deal General Trading & Contracting Co.
 P. O. Box 27956 Safat, 13140 Kuwait
 Tel: 965-245-7925 Fax: 965-242-3510

MONGOLIA

Tdels Co., Ltd.
 Sukhbaatar District 2 Khoroo Ubmart Center, Room #518
 Ulan Bator, Mongolia
 Tel: 976-1132-4414 Fax: 976-1132-4414

OMAN

North Ocean Enterprises L.L.C.
 P.O.Box 3725, P.C.112, Ruwi, Sultanate Of Oman
 Tel: 00968-92864334 Fax: 00968-24498622

PAKISTAN

Islamabad Industrial & Trading Corp.
 205 Amber Estate Shakra-e-faisal,
 Karachi - 75350, Pakistan
 Tel: 92-21-432-0601-5 Fax: 92-21-432-0617

PANAMA

Elevadores De Panama S.A.
 Via Ricardo J. Alfaro, Diagonal Hospital
 S.M. Arcangel Republic of Panama
 Tel: 507-230-3166 Fax: 507-230-3187

PHILIPPINES

Hyc Industrial Sales Corp. #81 Kapiligan Cor. Bayani St., Brgy.
 Dona Imelda, Quezon City, Philippines
 Tel: 63-2-716-0905/0923 Fax: 63-2-714-8896

QATAR

International Eng. & Trade Group Co.
 P. O. Box NO.22549 Doha, Qatar
 Tel: 97-4-436-6689 Fax: 97-4-556-8842

SAUDI ARABIA

ETA-Electromechanical & Technical Associates,
 Al Murjan Tower, 11th Floor, Suite #1104,
 Hail Street and Waly Al Ahd Street Intersection,
 P. O. Box 6591, Jeddah-21452, Saudi Arabia
 Tel: 966-2-652-9000 Fax: 966-2-652-9090

THAILAND

Loxley Public Co., Ltd.
 Construction Materials Department, 102 Na Ranong Rd,
 Klongtoey, Bangkok 10110, Thailand
 Tel: 66-2-348-8015 Fax: 66-2-240-3127/3128

TUNISIA

Ascenseurs Levage & Manutention(ALM)
 Rue Abderrahmen Ibn Aouf Cite Uv4
 Bloc 49-1004 Menzeh 6 tunis - Tunisie
 Tel: 216-71-236-373 Fax: 216-71-754-361

U.A.E.

Midein Electromechanical L.L.C.
 P.O. Box 27469 Abu Dhabi, U.A.E.
 Tel: 971-2-443-8181 Fax: 971-2-443-8822

Bin ham North Ocean Elevators L.L.C.

P.O. Box 81268 Dubai, U.A.E.
 Tel: 971-4-294-4475 Fax: 971-4-294-4476

U.S.A.

Park Bros, INC
 167 S Fuller AVE L.A.C.A.90036 U.S.A.
 Tel: 213-248-2239 E-mail: jino077@gmail.com

VENEZUELA

Cozy Life Elemecanico, C.A
 AV. Francisco De Miranda, Edif.Vesubio, Piso Pb,
 Local 01, URB. La California Norte, Caracas, Venezuela
 Tel: 58-212-232-1166 Fax: 58-212-232-7178

www.hyundaielevator.co.kr

Moving solutions with safety, reliability and efficiency

PASSENGER ELEVATORS

LUXEN | YZER | GEARED TRACTION

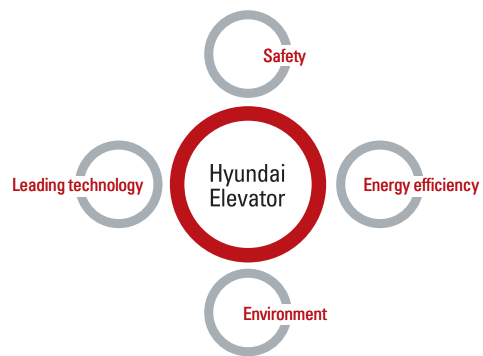

Since the 1984 founding of South Korea, Hyundai Elevator, an affiliate of Hyundai Business Group, with leading technology has grown up to Korea No. 1 elevator company. Now Hyundai Elevator is roaring towards to top of the world. We value the safety, energy efficiency, and environment-friendly features of the highest standard for all products made by Hyundai Elevator.



Trusted quality

With 3 overseas joint ventures and 3 overseas sales offices we export products to 50 countries like Japan, Europe, East / West Asia, the Middle East and are recognized for excellence in quality.

Refined design

Refined design to give consideration to health and the environment adds new value to the elevator.

[Selection of passenger elevator system]

The selection of elevators should be made in consideration of the building type/scale, tenant characteristics, elevator usage and the anticipated passenger carrying capacity at the building's traffic peak time.

Hyundai elevators are available from geared traction elevator to gearless traction elevators, covering the full range of vertical transportation requirements.

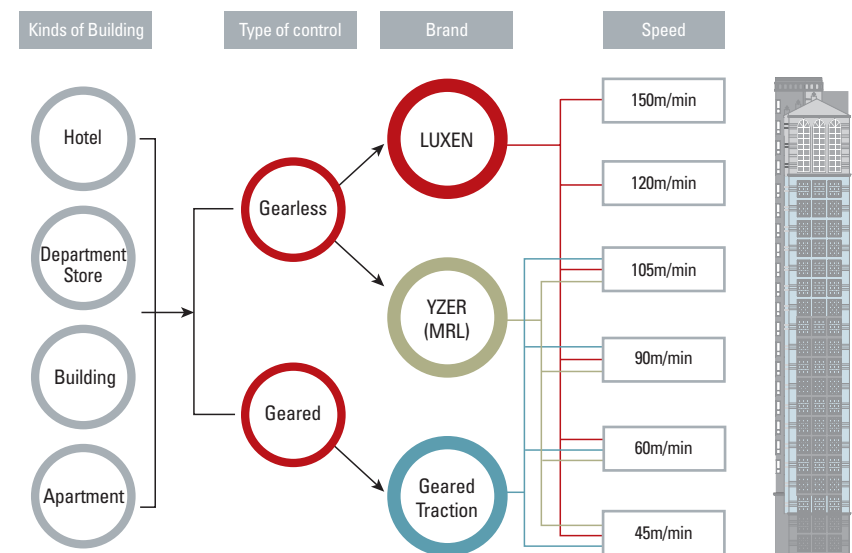

Contents

01 Advanced Technology Gearless Traction Machine • 04 / Energy Recycling Elevator Inverter • 06 / Reserving System for Target Floor • 08
 02 Reliable Brand LUXEN • 10 / YZER • 12 / Geared traction elevators • 14
 03 Design Car Design • 16 / Material Patterns • 22 / Ceiling Design • 25 / Signal Fixtures • 26 / Standard & Optional Features • 28 / Layout Plan • 30
 Works To Be Done By Other Contractors • 39 / Electric Power Requirements (By others) • 40

1

ADVANCED TECHNOLOGY

2

3

Gearless Traction Machine

With the use of gearless traction machine, smoother ride, improved energy-saving, and environment-friendly features are enhanced.

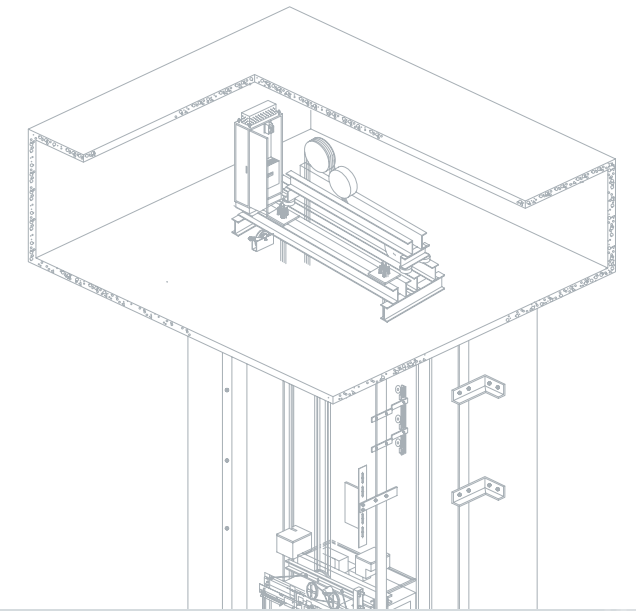

+ Improved energy savings

Gearless traction machine with permanent magnet synchronous motor provides up to 25 % energy savings compared with geared traction machine with induction motors.

+ Comfortable riding

Noise and vibration level have been decreased dramatically and car ride is improved thanks to the use of gearless traction machine with permanent magnet synchronous motor without toothing gear and rope swing.

+ Environment-friendly components

It is environmentally friendly because gear oil is not required.

+ Reduced installation space

It can save the building space as it needs smaller machine room space than the conventional.

+ Easy installation and maintenance

The installation and maintenance is less complicated as the implementation is the same 1:1 roping for induction motor.

Energy Regenerative Elevator Inverter-LOWATT

Capacitor-less condenser

LOWATT, next generation elevator inverter system, minimizes energy consumption by regenerating wasted kinetic energy with newly designed power circuit. It is applicable for low-medium speed gearless elevator LUXEN, machine roomless elevator YZER, and geared elevator.

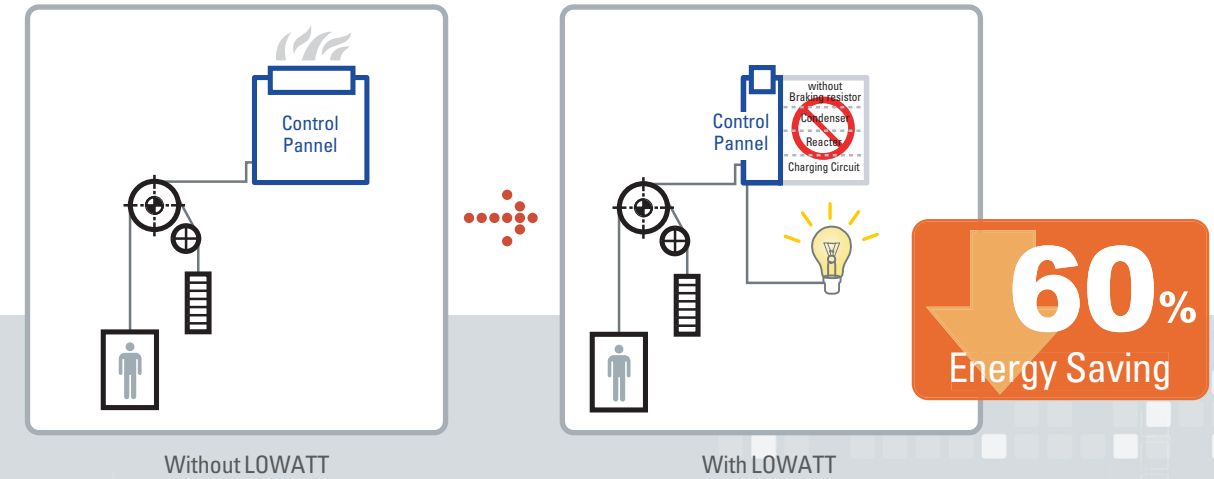

+ Up to 60% energy savings

The energy generated by the motion of the car is recycled back to the inverter, resulting a 60% total energy consumption.

+ Reduced heat emission

The heat emission of the motor has been drastically reduced as the energy generated from operating the elevator is recycled.

+ Easy maintenance

The inverter doesn't have condensers, reactors, resistant parts so it is easy to maintain and repair.

Notes : 1. Energy Regenerative Elevator Inverter(LOWATT) is optional.
2. In Dec., 2007 the Ministry of Science and Technology certified the NET(New Excellent Technology) for the capacitor-less inverter control for driving elevator.

LOWATT



Destination Selecting System

The purpose of registration is to automatically select the best service of the elevator car within the system and the passenger does not need to click the car operating button in car. Destination Selecting System manages elevator more effectively.



+ Shorter waiting time

It saves calling time and riding time as it selects the proper elevator for effective service.



+ Improving efficiency in energy usage

By grouping passengers having the same target floor to the same elevator, it will save energy and increase system efficiency.

+ Security and Convenience

Use of Building Access Cards to work with the elevator call button and the user ID in the Building Access Cards will automatically register a call to provide convenience to residents, as well as preventing any non-authorized outsider gain access to the building.

+ A variety of contents in real time

This system can be applied to existing systems and this feature will provide a touch screen and LCD display inside the car, so passengers can get internet-based information such as car operation, weather, stock price, index trends, and real-time headline news.

Medium speed gearless traction elevators (LUXEN)

A high-tech gearless traction machine which was used mainly in high-speed elevator is used for this product.

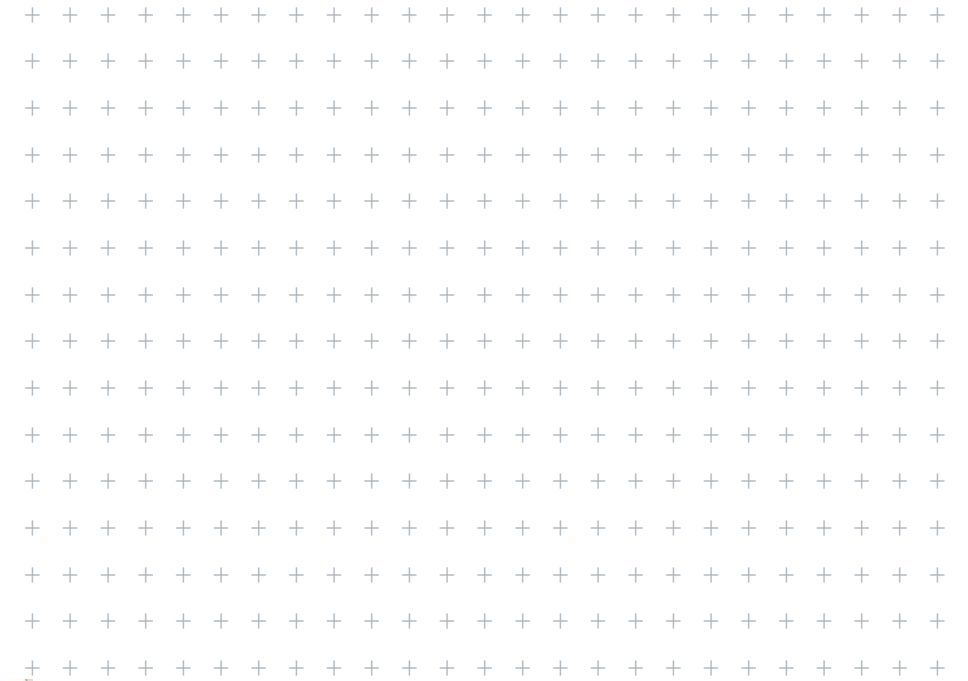

LUXEN Digital Gearless

Excellent car ride

The LUXEN, using the gearless machine, provides a smooth and noiseless ride.

Increased energy efficiency

Gearless traction machine with permanent magnet synchronous motor application and energy recycling Inverters(LOWATT) will increase energy efficiency.

Spacious car Interior

The car is more spacious and more comfortable compared with existing product design which has low ceiling height.

Eco-friendly Product

This is an environment-friendly products. It does not need to replace the gear oil regularly.

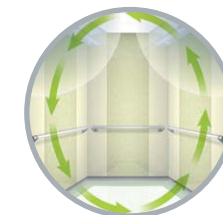

Machine-room-less elevators (YZER)

An innovative elevator which does not require a separate machine room.

Machine Room Less

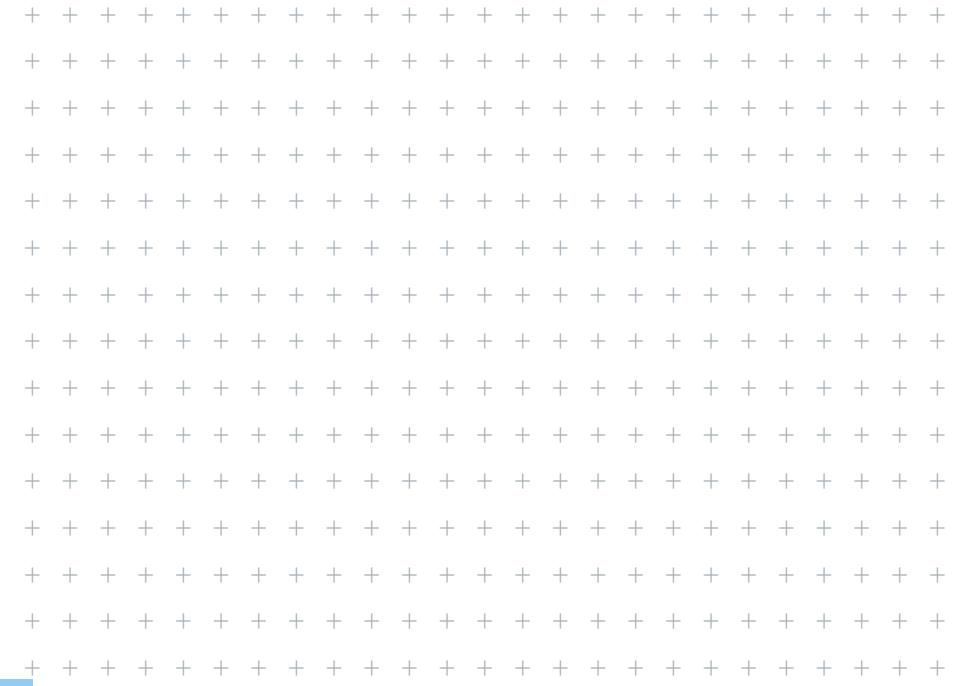

High space efficiency
The thinner control panel and compact gearless traction machine eliminate the need for a separate machine room because the system is so compact it can be located at any floor or on hoistway wall.

More flexible architectural design
The building roof line can be enhanced due to the elimination of the conventional penthouse type machine room. It enables a free layout of hoistway position as the machine room is not necessary.

Reduction of building cost
Expenses for the construction of machine room as well as the completion time of building work can be reduced as the machine room is not necessary.

Compact gearless traction machine
By using gearless traction machine with permanent magnet synchronous motor, it provides smoother ride, improved energy-saving, and environment friendly features.



Geared Traction Elevators

The highest efficiency is achieved through the optimal combination of voltage and frequency, the latest and most advanced VVVF technology of electric power supply to the induction motor.

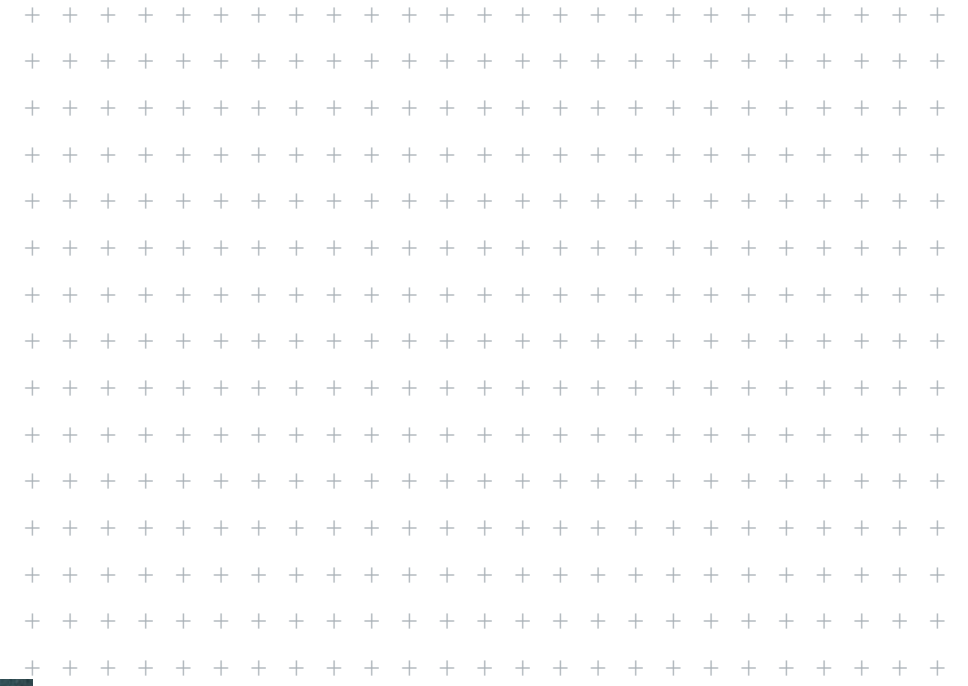

Extremely smooth riding comfort & accurate landing
Using computer control for acceleration and deceleration the riding comfort is improved.

Enhanced safety
The self-checking system as part of the software/hardware design built-in the elevator and drive control system greatly improve safety of the elevator operation.

Compact design
Minimized control panel enables to reduce installation costs.





| FRONT VIEW |



| REAR VIEW |



| FRONT VIEW |



| REAR VIEW |



| CAGE DESIGN |

Ceiling	CD597A, Painted Steel (P021), Skylite 10T, Indirect Lighting
Wall	Hairline-Finished Stainless Steel, Hairline Etched Stainless Steel (SE1172)
Car Doors	Hairline Etched Stainless Steel (SE1172)
Operating Panel	OPP-N241B / OPP-N241W (Hairline-Finished Stainless Steel)
Indicator	PI-D110
Handrail	Stainless Steel 1 Pipe / Polished (1B)
Flooring	Sense Tile (TN2402C)

Notes: 1. Finished product may vary slightly from these prints.
 2. The price will vary depending on the customer's specification.
 3. The split may vary depending on the capacity.



| CAGE DESIGN |

Ceiling	CD451B, Acryl, Acryl Lens, Painted Steel (P022)
Wall	Hairline Etched Stainless Steel (SE1169)
Car Doors	Hairline Etched Stainless Steel (SE1169)
Operating Panel	OPP-N240B
Indicator	PI-D600
Handrail	Stainless Steel 1 Pipe (1A)
Flooring	Polyvinyl Tile (TN2401C, TN2406C)

Notes: 1. Finished product may vary slightly from these prints.
 2. The price will vary depending on the customer's specification.
 3. The split may vary depending on the capacity.



| FRONT VIEW |



| REAR VIEW |



| FRONT VIEW |



| REAR VIEW |



| CAGE DESIGN |

Ceiling	CD253A, Painted Steel (P021, P022), Skylite 10T, LED Down Light
Wall	Hairline Etched Stainless Steel (SE1168), Hairline-Finished Stainless Steel
Car Doors	Hairline Etched Stainless Steel (SE1168)
Operating Panel	OPP-N240B / OPP-N240W (Hairline-Finished Stainless Steel)
Indicator	PI-D110
Handrail	Stainless Steel 1 Pipe + Coated Chrome Bracket (1B)
Flooring	Polyvinyl Tile (DTE2241, DTE2246)

Notes: 1. Finished product may vary slightly from these prints.
 2. The price will vary depending on the customer's specification.
 3. The split may vary depending on the capacity.



| CAGE DESIGN |

Ceiling	CD291C, Acryl, Painted Steel (P021)
Wall	Mirror-Trimmed Stainless Steel, Hairline Etched Stainless Steel (SE1673)
Car Doors	Hairline Etched Stainless Steel (SE1673)
Operating Panel	OPP-N241B
Indicator	PI-D110
Handrail	Stainless Steel 1 Pipe + Coated Chrome Bracket (1B)
Flooring	Polyvinyl Tile (TN2422C, TN2601C)

Notes: 1. Finished product may vary slightly from these prints.
 2. The price will vary depending on the customer's specification.
 3. The split may vary depending on the capacity.



| FRONT VIEW |



| REAR VIEW |



| FRONT VIEW |



| REAR VIEW |



| CAGE DESIGN |

Ceiling	CD516C(Indirect Lighting), Convective Air Sterilization System
Wall	Dull-Finished Stainless Steel, Pearl Glossy (AFG247)
Car Doors	Pearl Glossy (AFG247)
Operating Panel	OPP-D240B / OPP-N640 (For the disabled)
Handrail	Stainless Steel 1 Pipe (1A)
Flooring	Polyvinyl Tile (DTF5311, DTF5907)

Notes: 1. Finished product may vary slightly from these prints.
 2. The price will vary depending on the customer's specification.
 3. The split may vary depending on the capacity.
 4. For OPP-N640 under 1150Kg (17 persons), the thickness of the side central wall of car could be obtrusive about 100 mm.



| CAGE DESIGN |

Ceiling	CD251A, Painted Steel (P022), Acryl, Convective Air Sterilization System
Wall	Hairline-Finished Stainless Steel, Mirror-Etched Stainless Steel (SE1184)
Car Doors	Mirror-Etched Stainless Steel (SE1171)
Operating Panel	OPP-N241B (Mirror-Finished Stainless Steel)
Indicator	PI-D110 (Dot Type)
Handrail	Stainless Steel 1 Pipe + Aluminum die casting (1A)
Flooring	Marble

Notes: 1. Finished product may vary slightly from these prints.
 2. The price will vary depending on the customer's specification.
 3. The split may vary depending on the capacity.

Entrance(Etching)

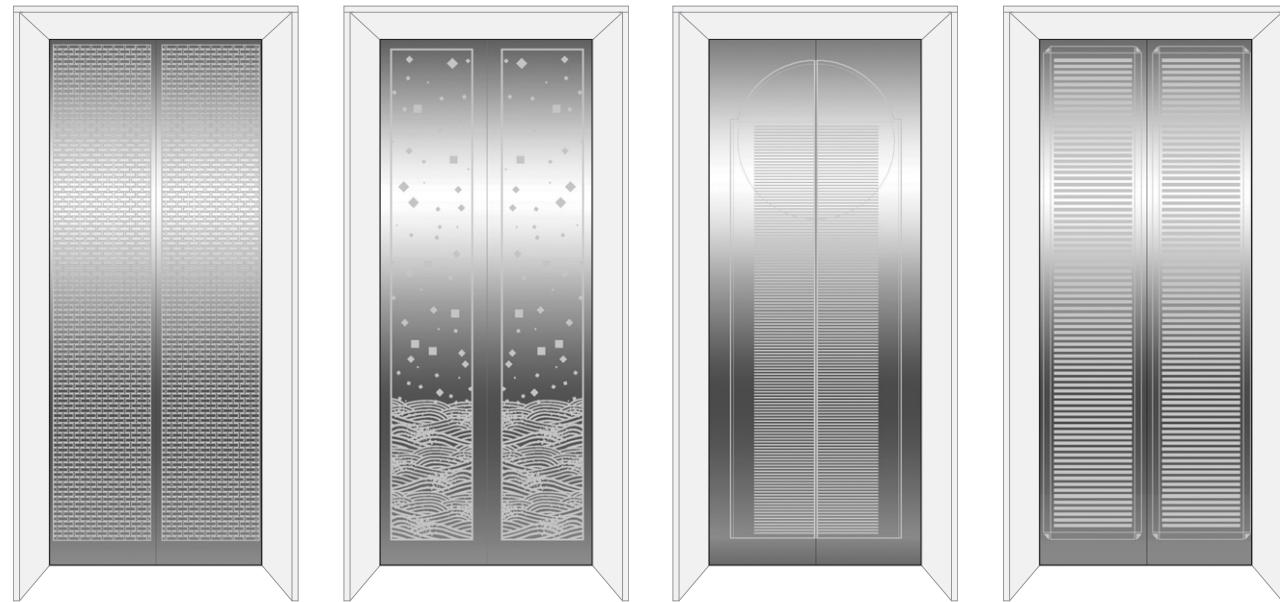

EE001
(SE695)

EE002
(SE692)

EE003
(SE691)

EE005
(SE614)



EE006
(SE743)

EE007
(SE1168)

EE008
(SE1171)

EE009
(SE1172)

Notes: 1. It's different from actual size.
2. ■ : Emboss pattern □ : Intaglio Pattern
3. If the above etching patterns are applied for fire protection doors, the left door is 20 mm bigger than the right one. Consult Hyundai.

4. Etching patterns shown above are available for car doors and entrance doors.
5. For entrance opening, EE002, EE003, EE008 are not applied.

Etching



SE403

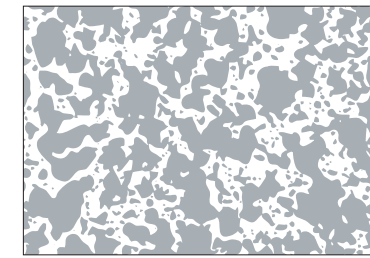

SE409

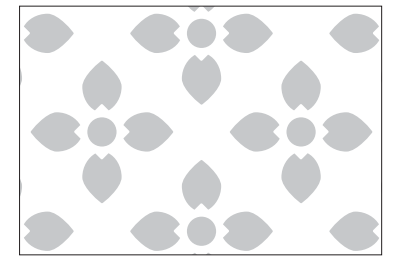

SE424

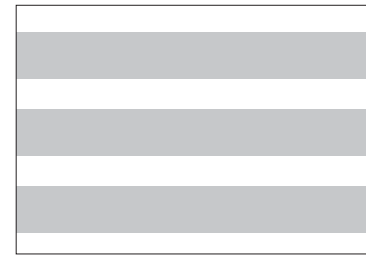

SE439

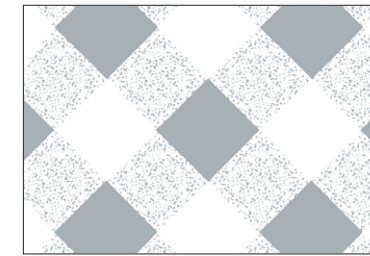

SE785

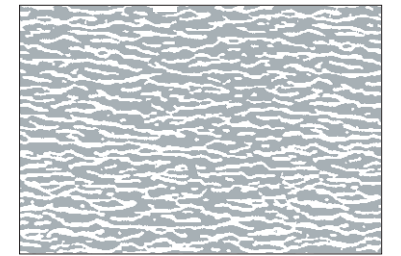

SE859

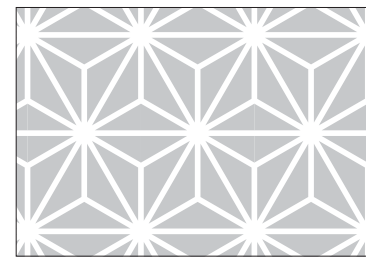

SE928

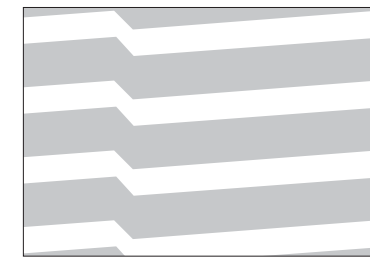

SE1168

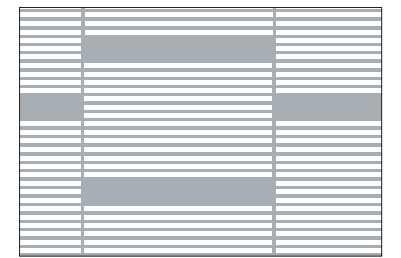

SE1169

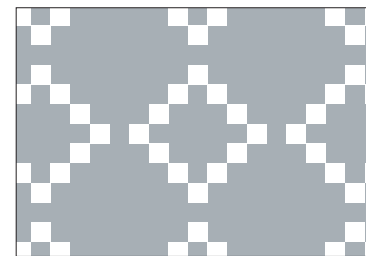

SE1172

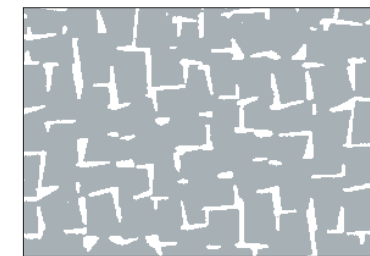

SE1184



SE1589



SE1590

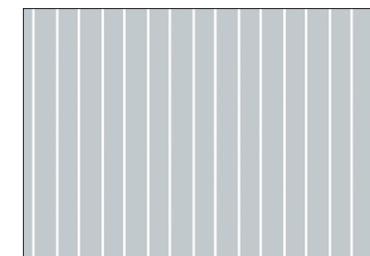

SE1591 (1mm line by 8mm spaces)

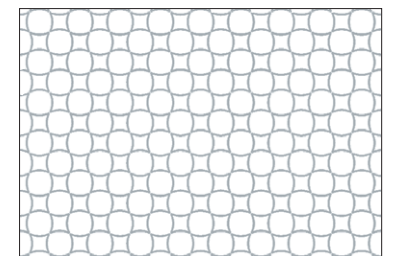

SE1673

Notes: 1. It's different from actual size.
2. ■ : Emboss pattern □ : Intaglio Pattern

Paint Color



P003 (2.3Y 8.5/2.5)



P006 (2.5GY 7/12)



P008 (8.5YR 7.1/12.5)



P009 (4.5B 7.8/2.0)



P011 (4.1R 4.3/12.8)



P012 (2.3PB 4.5/9.6)



P016 (9.9YR 5.0/3.1)



P017 (6.7Y 8.7/2.0)



P019 (5.1Y 7.6/1.1)



P020 (Metallic Gold)



P021 (Metallic Silver)



P022 (Black)

Note: Finished product may vary slightly from these prints.

Polyvinyl Tile

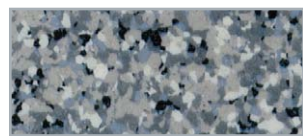

86516

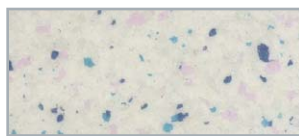

86541



86545



86553



TN2234M



TN2235M



TN2231C



TN2230C



TN2422C



TN2233C



TN2601C

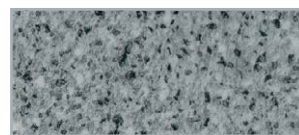

TN2604C

Note: Finished product may vary slightly from these prints.

Ceiling



CD251A
(P022 / Acryl / Convective Air Sterilization System)

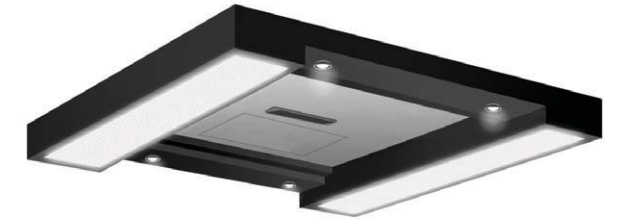

CD253A
(P021, P022 / Skylite 10T / LED Down Light)

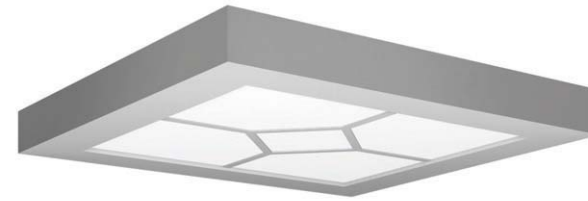

CD291C
(P021)



CD451B
(P022)



CD516B
(Indirect Lighting / Convective Air Sterilization System)



CD516C
(Indirect Lighting / Metallic Silver / Convective Air Sterilization System)



CD519D
(Indirect Lighting / Aluminium Silver / Convective Air Sterilization System)



CD597A
(P007, Lusterless White / Skylite 10T / Indirect Lighting)

Notes: 1. Finished product may vary slightly from these prints.
2. The color of painted steel sheet can be changed according to the car wall color.
3. If car wall is stainless steel, P019 is recommended. The other materials need to be specified separately.

Car Operating Panels



Hall Buttons with Indicator



Notes: 1. Finished product may vary slightly from these prints.
2. 30 type button is not available for HPB-640, HPB-641, HIP-D640 and HBI-64A.
3. If card key system is applied, please select the box type hall button as card key system can not be applied on boxless hall button.

Position Indicators



Note: * means optional feature.

Hall Buttons



Type of Buttons



Remote Elevator Calling Button(Optional)

To minimize waiting time at a special floor, a special car calling button can be installed in an office (e.g. Secretary for a CEO office) or in a penthouse (e.g. Penthouse for Executives or Government Officials or Special Guests) or in a high-rise apartment.



Handrail

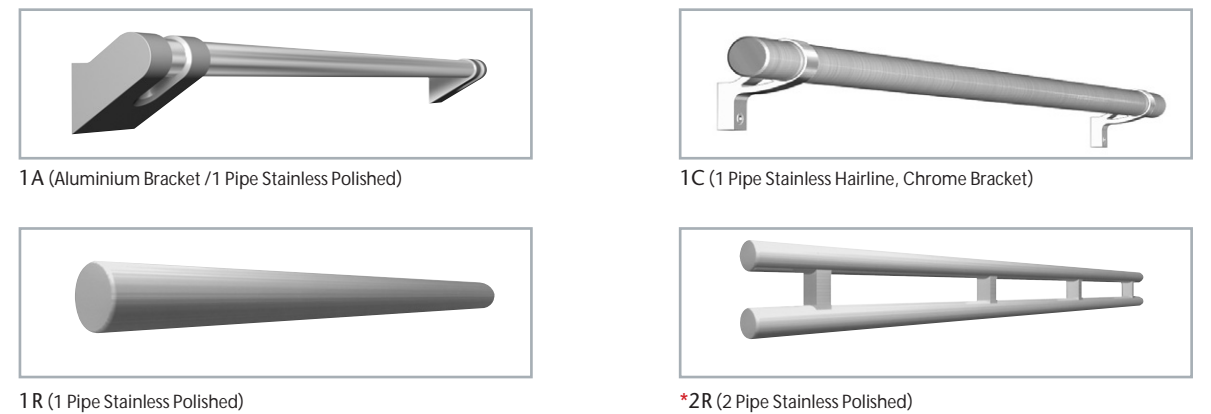

Notes: 1. * means optional feature. 2. Finished product may vary slightly from these prints.

Standard & Optional Features

Items	Descriptions	Marks
1) Selective collective	The first call determines the direction of the elevator. All calls opposing the respective direction are serviced after carrying out by the calls of the respective direction.	○
2) Duplex selective collective	2 units of elevator provide the effective service for the common hall calls	★
3) Automatic bypass	When a car is 80% loaded, it will automatically bypass all hall calls as the bypass load weighing device is activated.	○
4) Chime bell	It provides an audible indication in the car that an elevator is about to arrive.	○
5) Signal fixtures	Digital(Segment) type Dot matrix type(moving direction) Hall lantern	○ ★ ★
6) Single-side safety edge of door	Contact with a passenger or inanimate object causes the doors to stop and reopen automatically. The elevator doesn't start if the door is completely not closed.	○
7) Ventilation fan	Car ventilation is smooth with ventilation fan built-in the ceiling.	○
8) Emergency car lighting	In case of the power failure, it lights automatically in the car.	○
9) Automatic interruption of light and ventilation fan	The lights and ventilation fan are automatically turned off to save energy if there is no call registered for a period of time. If there is a call registered again, it works again.	○
10) Door interlock switch	When the door is opened, the switch installed at the door operator is activated and keeps the car from moving. During the operation of car, it locks the door completely so as not to open the door from out side.	○
11) Interphone & emergency call button	In case of emergency, the passenger can communicate with the personnel in control room or in prevention center of disasters by pushing the emergency call button.	○
12) Overload features	To protect the overload of elevator, this device sounds a buzzer and the elevator remains stopped at that floor when the number of passengers exceeds the rated capacity. When the excess number of passengers get out of the car, the buzzer stops and the elevator door closes.	○
13) Safety drive	During the operation if the car stops between floors, and safety device doesn't work, the car automatically moves to the nearest floor with the low speed. Then, it opens the door to allow the passengers to exit off.	○

Items	Descriptions	Marks
14) Multi-beam door protection	Multi-beam from the top to the bottom of the door senses any obstruction caught in the door. It makes the door reopen, or keep open/close before the door is touched such obstruction.	★
15) Fire emergency service	When a fire breaks out, all cars activated by the switch or fire detector are immediately called to a specified rescue floor for the passenger's safety.	★
16) Anti- nuisance	Evaluates the number of people on the car and compares that value to the number of the car calls registered. If the number of car calls exceeds the number of people in the car by the load sensor, the car call exceeding the number of passengers will be cancelled after service nearest all only.	★
17) Voice synthesizer	A voice synthesizer with microprocessor makes announcements to inform passengers of various conditions, including landing floor and operation direction, etc.	★
18) Emergency power operation	During normal power failure, elevator service continues with building's emergency power source.	★
19) Fireman's emergency service	When the fireman's switch located at the main floor lobby and operating panel on the car is activated during a fire or other emergency, a designated car can be called back to a specified floor for fire fighting service.	★
20) HELMON (Hyundai Elevator Computer Monitoring) System	This system has a various function like elevator monitoring and control by the personal computer and modem.	★
21) Emergency landing device(ELD)	In the event of the power failure, the elevator power automatically switches to a rechargeable battery built-in controller that moves the car to the nearest floor and allows passengers to safely exit. This can be used when no emergency power source in the building is available.	★
22) Attendant service	It is activated when the attendant turns on the ATT switch in the car operating panel to "ON" position.	★
23) Earthquake operation	When the seismic sensor detects and earthquake that exceeds a predetermined level, all cars promptly proceed to land at the nearest floor and park with the doors open to allow passengers to exit out safely.	★
24) Parking	The car can be parked at a specified floor, during the nights or holidays with operate parking switch on hall button.	★

Notes: 1. ○ : Standard, ★ : Optional
2. Consult Hyundai if you need the specific features except the above items.

Plan of Hoistway & Machine Room

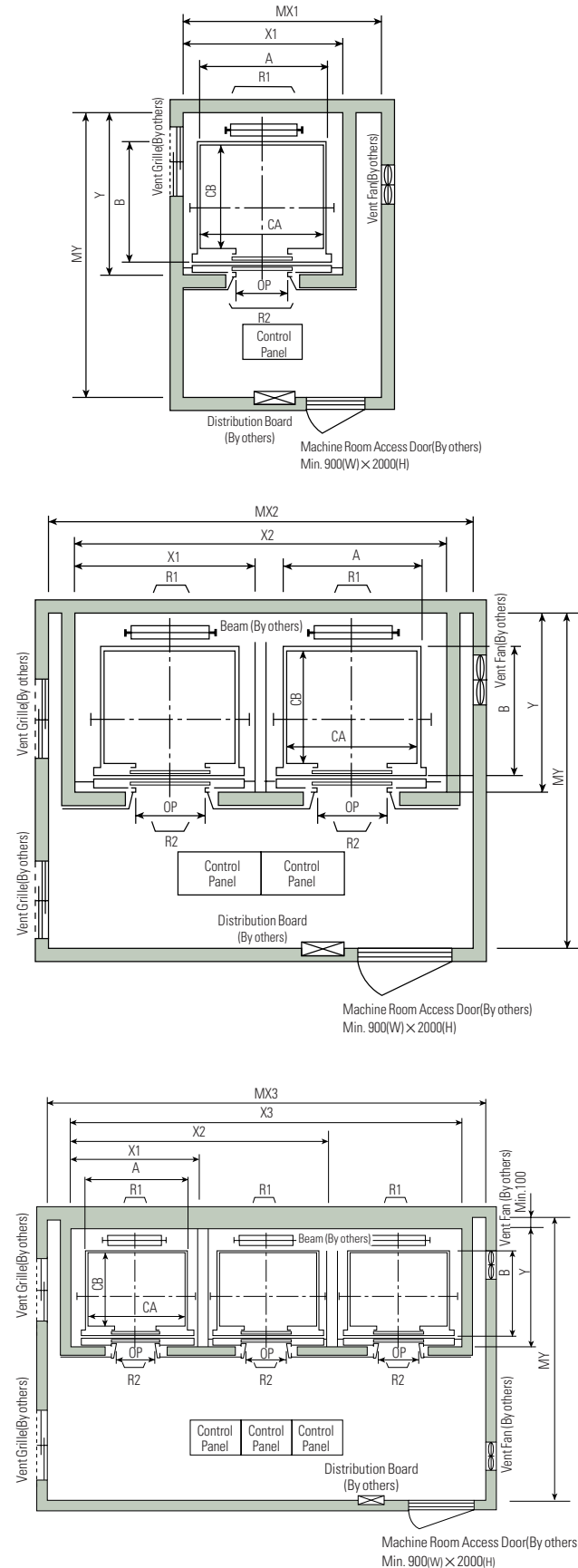

Section of Hoistway

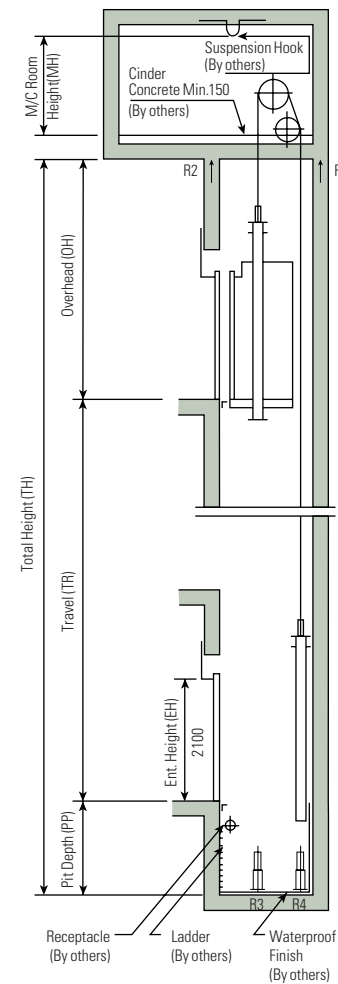

Standard Dimensions & Reactions

(Unit: mm)

Speed (m/min)	Capacity		Clear Opening OP	Car		Hoistway				M/C Room				M/C Room Reaction(kg)	
	Persons	kg		Internal CA x CB	External A x B	1Car X1	2Cars X2	3Cars X3	Depth Y	1Car MX1	2Cars MX2	3Cars MX3	Depth MY	R1	R2
60	6	450	800	1400 x 850	1460 x 1005	1800	3700	5600	1430	2000	4000	6000	3200	3600	2000
	8	550	800	1400 x 1030	1460 x 1185	1800	3700	5600	1610	2000	4000	6000	3400	4050	2250
	9	600	800	1400 x 1130	1460 x 1285	1800	3700	5600	1710	2000	4000	6000	3500	4100	2450
90	10	700	800	1400 x 1250	1460 x 1405	1800	3700	5600	1830	2000	4000	6000	3600	4200	2700
	11	750	800	1400 x 1350	1460 x 1505	1800	3700	5600	1930	2000	4000	6000	3700	4550	2800
105	13	900	900	1600 x 1350	1660 x 1505	2050	4200	6350	1980	2300	4400	6800	3750	5100	3750
	15	1000	900	1600 x 1500	1660 x 1655	2050	4200	6350	2130	2300	4400	6800	3850	5450	4300
120	17	1150	1000	1800 x 1500	1900 x 1670	2350	4800	7250	2180	2600	4900	7500	3900	6600	5100
			1100	2000 x 1350	2100 x 1520	2550	5200	7850	2030	2800	5250	8300	3800		
150	20	1350	1000	1800 x 1700	1900 x 1870	2350	4800	7250	2380	2600	4900	7500	4200	7800	6000
			1100	2000 x 1500	2100 x 1670	2550	5200	7850	2180	2800	5250	8300	4000		
			1100	2000 x 1750	2100 x 1920	2550	5200	7850	2430	2900	5400	8300	4300		
	24	1600	1100	2150 x 1600	2250 x 1770	2700	5500	8300	2280	3000	5650	8700	4200	8500	6800

- Notes:**
- Above hoistway dimensions are based on 15-storied buildings. For application to over 16-storied buildings, the hoistway dimensions shall be at least 5% larger considering the sloping of the hoistways.
 - Above dimensions are based on center opening doors. For applicable dimensions with side opening doors, consult Hyundai.
 - When non-standard capacities and dimensions are required to meet the local code, consult Hyundai.
 - The capacity in persons is calculated at 65kg/person. (EN81:75kg/person)
 - Above dimensions are applied in case the door is standard. In case fire protection door is applied, hoistway size for 1 car should be applied above X1 dimension plus 100mm.
 - In case of 120m/min and 150m/min, the dimension of X1 is X1 plus 100mm.

(Unit: mm)

Speed (m/min)	Overhead (OH)	Pit (PP)	M/C Room Height (MH)
60	4600	1500	2200
90	4800	1800	2400
105	5000	2100	2400
120	5000	2100	2600
150	5500	2400	2600

Note: Machine room temperature should be maintained below 40°C with ventilating fan and/or air conditioner(if necessary) and humidity below 90%.

Layout Plan - YZER(Machine-Room-Less Elevators) 60~105m/min

Plan of Hoistway & Machine Room (8~17 Person)

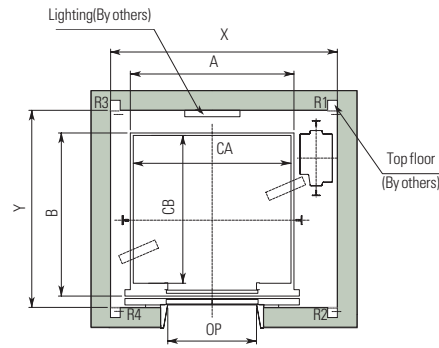

Floor without control panel

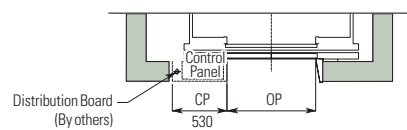

Floor with control panel

Note: The lighting of hoistway should be installed less than 500 mm from above the ceiling of hoistway and within 500 mm above the bottom of the pit. (By others)

Section of Hoistway

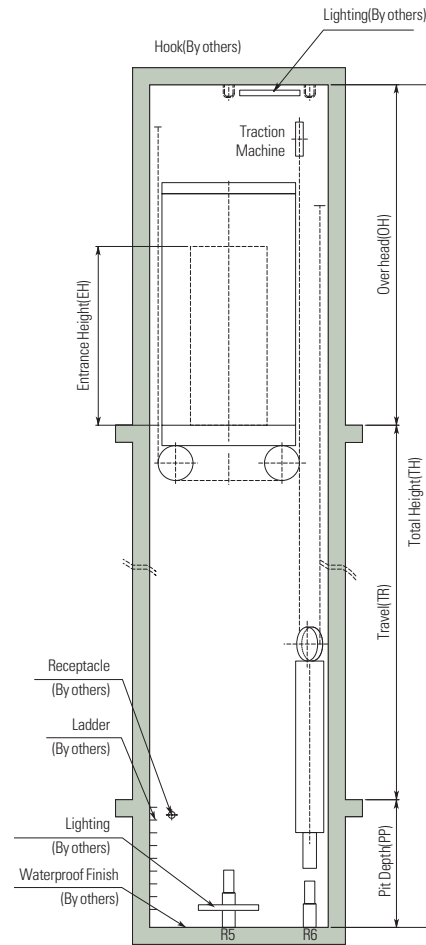

Standard Dimensions (8~17 Person)

(Unit: mm)

Speed (m/min)	Capacity		Clear Opening OP	Car		Hoistway		Motor (kW)
	Persons	kg		Internal CA×CB	External A×B	1 Car X	Depth Y	
60	8	550	800	1300×1100	1360×1255	2050	1700	3.4
90								5.1
105								5.9
60	9	600	800	1300×1190	1360×1345	2050	1800	3.7
90								5.6
105								6.5
60	10	700	800	1300×1300	1360×1455	2050	1800	4.3
90								6.5
105								7.5
60	11	750	800	1300×1400	1360×1555	2050	1850	4.6
90								6.9
105								8.1
60	13	900	900	1600×1300	1660×1455	2300	1800	5.6
90								8.3
105								9.7
60	15	1000	900	1600×1400	1660×1555	2300	1900 (2100)	6.2
90								9.2
105								10.8
60	17	1150	1000	1800×1400	1900×1570	2600	2100	7.1
90								10.6
105								12.4

- Notes:
- The dimension in () is for the heavy car weight such as the car floor using finished granite.
 - When non-standard capacities and dimensions (including fire protection doors) are required to meet the local code, please consult Hyundai.
 - The minimum hoistway dimensions are shown on the above table. Therefore, some allowances should be made considering the sloping of the hoistways.
 - In case of elevator for disable, the dimension of CA is more than 1600 mm, CB more than 1350 mm.
 - If the height of floor is over 11 m, please consult Hyundai as to the needs for emergency exit.
 - Above dimensions are applied to standard door only. In case fire protection door is applied, hoistway size for 1 car should be applied above X1 dimensions plus 100 mm and over.

Standard Dimensions (20, 24 Person)

(Unit: mm)

Speed (m/min)	Capacity		Clear opening OP	Car		Hoistway		Motor (kW)
	Person	kg		Internal CA×CB	External A×B	1 Car X	Depth Y	
60	20	1350	1000	1800×1600	1900×1770	2625	2400	8.3
90								12.5
105								14.5
60	24	1600	1100	2000×1700	2100×1870	2825	2450	9.9
90								14.8
105								17.2

- Notes:
- When non-standard capacities and dimensions are required to meet the local code, please consult Hyundai.
 - The minimum hoistway dimensions are shown on the above table. Therefore, some allowances should be made considering the sloping of the hoistways.
 - Consult Hyundai if the emergency stop device is installed on the counterweight.

Plan of Hoistway & Machine Room (20, 24 Person)

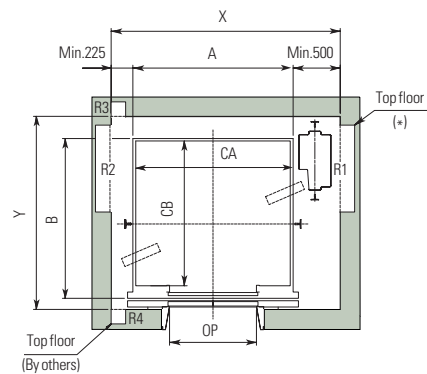

Floor without control panel

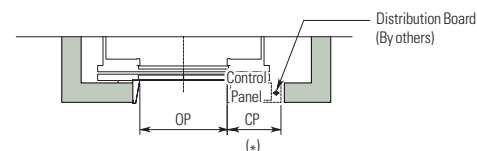

Floor with control panel

Persons	Speed (m/min)	Overhead (OH)	Pit (PP)	Control panel (CP)(*)
8~17	60	3800	1500	530
	90	3900	1800	
	105	4000	2100	
20, 24	60	4200	1500	530
	90	4350	1800	630
	105	4450	2100	630

- Notes:
- Above dimensions are applied for car height of 2500 mm (car internal height is 2300 mm). For other applicable dimensions, consult Hyundai.
 - For car internal height (under 17 persons) of 2500 mm, dimension of overhead is OH plus 200mm.
 - If the dimension between the wall of hoistway and car external dimensions (A, B) is in excess of over 850 mm, the dimension of overhead is OH plus 200mm.
 - The minimum hoistway dimensions are shown on the above table. Therefore, some allowances should be made considering the sloping of the hoistways.
 - When face to face arrangement is required, partitioning work for hoistway is required.
 - If the hoistway is glass, consult Hyundai as it needs to finish joining glass.
 - The lighting should be installed at the top and bottom of hoistway.

Reactions

(Unit: mm)

Persons	M/C Room Reaction(kg)				Pit Reaction(kg)			
	R1	R2	R3	R4	R5		R6	
					Speed (m/min)		Speed (m/min)	
8~17	8000	3500	1500	3000	Under 60	10000	Under 60	8000
					90.105	14000	90.105	12000
20, 24	14000	3800	1500	4500	Under 60	12000	Under 60	9500
					90.105	21500	90.105	17500

- Notes:
- The minimum dimensions for the standard are shown on the above table. Consult Hyundai in case of non-standard.
 - Consult Hyundai if the hoistway is steel structure.

Layout Plan – Geared Elevators 60~105m/min

Plan of Hoistway & Machine Room

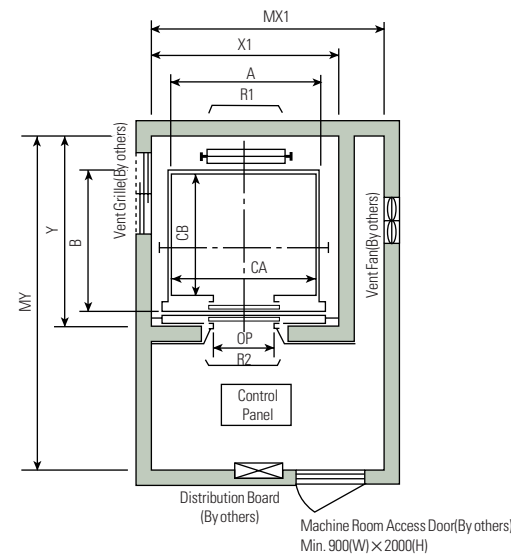

Note: Machine room temperature should be maintained below 40°C with ventilating fan and/or air conditioner (if necessary) and humidity below 90%.

Section of Hoistway

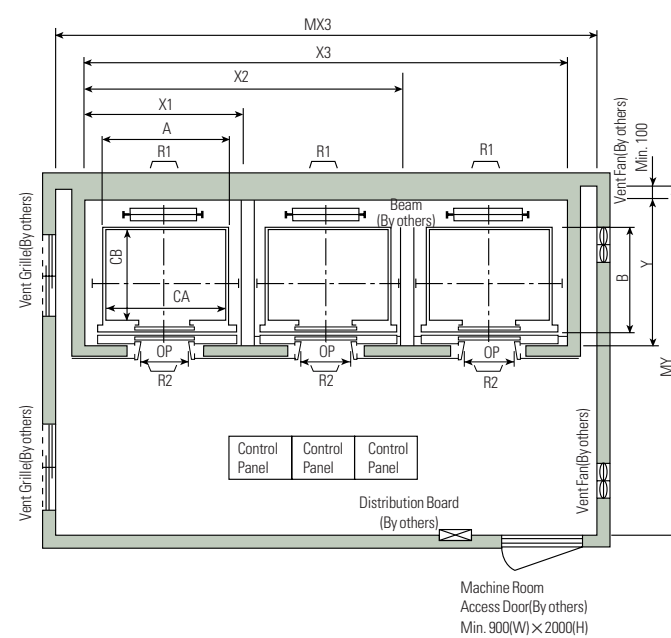
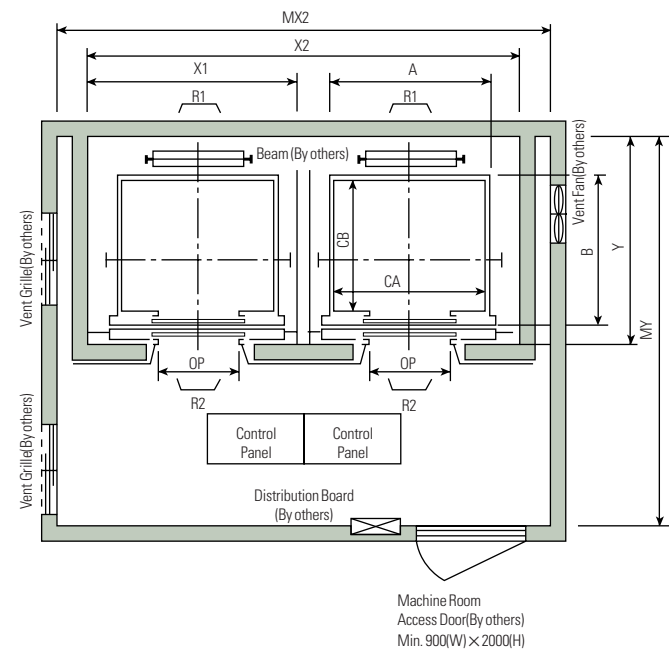
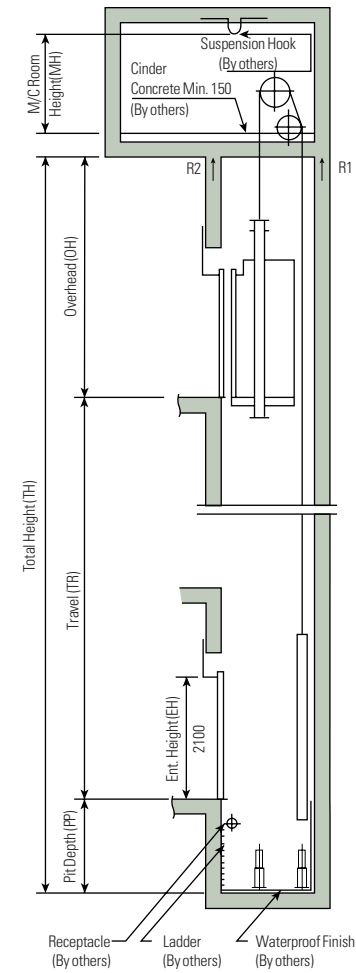

Standard Dimensions & Reactions

(Unit: mm)

Speed (m/min)	Capacity		Clear Opening OP	Car		Hoistway				M/C Room				M/C Room Reaction (kg)	
	Persons	kg		Internal CA × CB	External A × B	1Car X1	2Cars X2	3Cars X3	Depth Y	1Car MX1	2Cars MX2	3Cars MX3	Depth MY	R1	R2
60	6	450	800	1400 × 850	1460 × 1005	1800	3700	5600	1430	2000	4000	6000	3200	3600	2000
	8	550	800	1400 × 1030	1460 × 1185	1800	3700	5600	1610	2000	4000	6000	3400	4050	2250
	9	600	800	1400 × 1130	1460 × 1285	1800	3700	5600	1710	2000	4000	6000	3500	4100	2450
	10	700	800	1400 × 1250	1460 × 1405	1800	3700	5600	1830	2000	4000	6000	3600	4200	2700
	11	750	800	1400 × 1350	1460 × 1505	1800	3700	5600	1930	2000	4000	6000	3700	4550	2800
90	15	1000	900	1600 × 1350	1660 × 1505	2050	4200	6350	1980	2300	4400	6800	3750	5100	3750
			1000	1800 × 1500	1900 × 1670	2350	4800	7250	2180	2600	4900	7500	3900	6600	5100
105	20	1350	1000	1800 × 1700	1900 × 1870	2350	4800	7250	2380	2600	4900	7500	4200	7800	6000
			1100	2000 × 1500	2100 × 1670	2550	5200	7850	2180	2800	5250	8300	4000		
	24	1600	1100	2000 × 1750	2100 × 1920	2550	5200	7850	2430	2900	5400	8300	4300	8500	6800
				2150 × 1600	2250 × 1770	2700	5500	8300	2280	3000	5650	8700	4200		

- Notes:**
- Above hoistway dimensions are based on 15-storied buildings. For application to over 16-storied buildings, the hoistway dimensions shall be at least 5% larger considering the sloping of the hoistways.
 - Above dimensions are based on center opening doors. For applicable dimensions with side opening doors, consult Hyundai.
 - When non-standard capacities and dimensions are required to meet the local code, consult Hyundai.
 - The capacity in persons is calculated at 65kg/person. (EN81:75kg/person)
 - Above dimensions are applied in case the door is standard. In case fire protection door is applied, hoistway size for 1 car should be applied above X1 dimension plus 100mm.

(Unit: mm)

Speed (m/min)	Overhead (OH)	Pit (PP)	M/C Room Height (MH)
60	4600	1500	2200
90	4800	1800	2400
105	5000	2100	2400

Note: The minimum hoistway dimensions are shown on the above table. Therefore, some allowances should be made considering the sloping of the hoistways.

Entrance

Structural Opening of Entrance

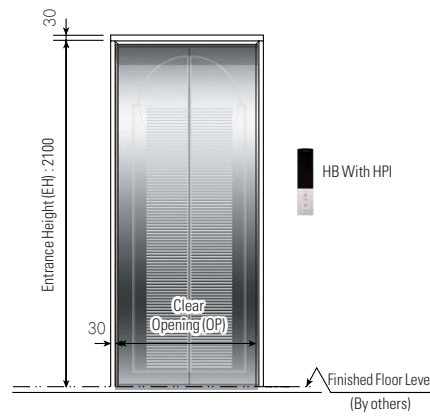

JP050 Type (Basic)

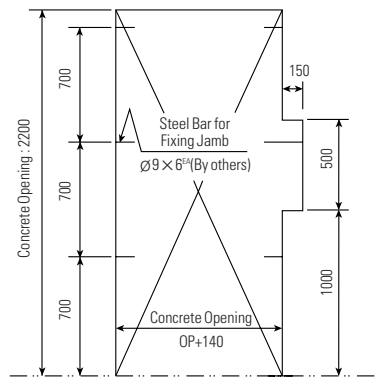

In case of Boxless Type Buttons and Fire man's Switch

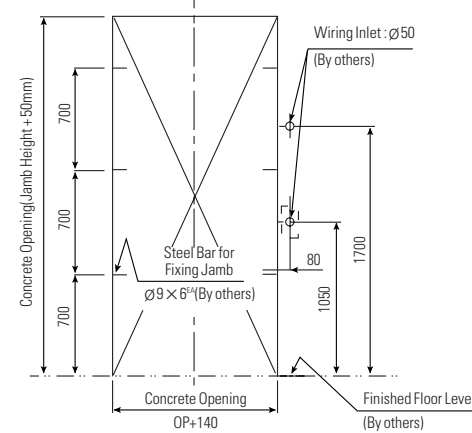

Entrance Design

Structural Opening of Entrance

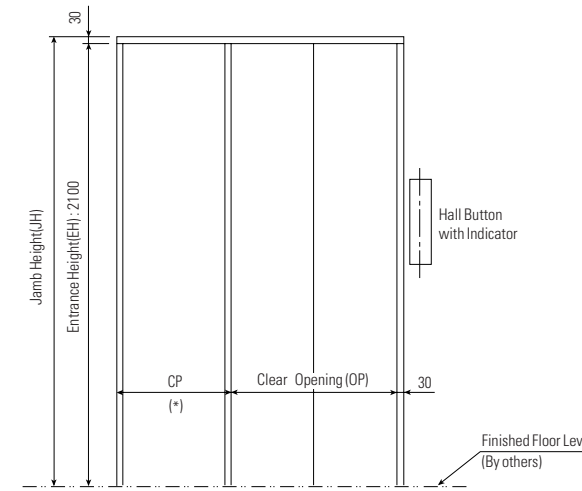

CP110 Type (Standard)

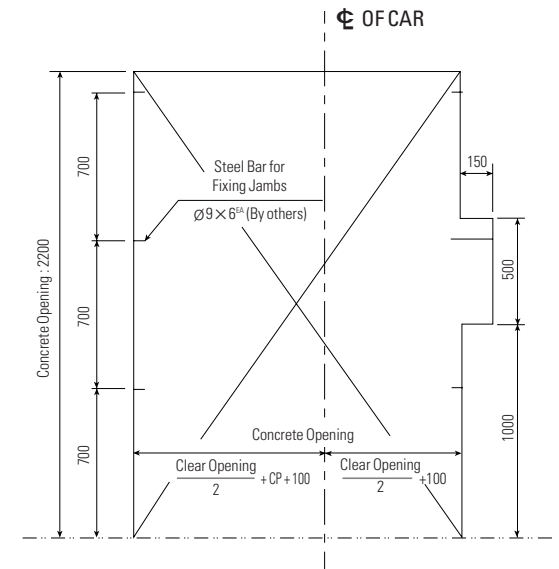

CP110 Type (Standard)

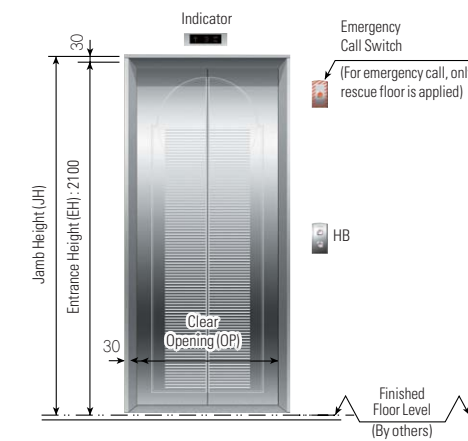

JP100 Type (Optional)

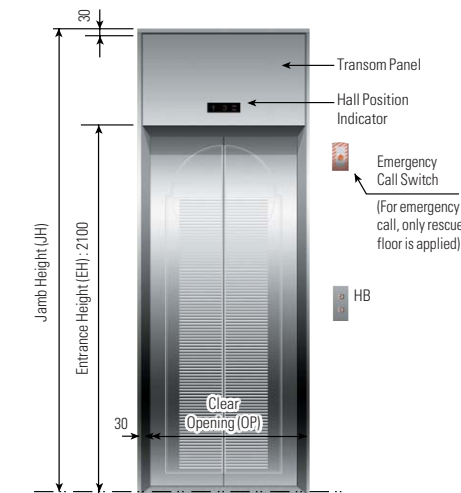
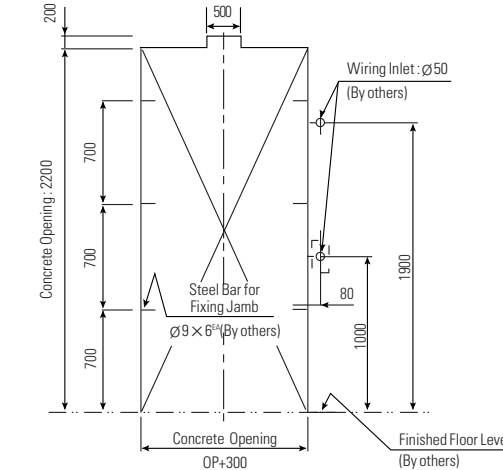
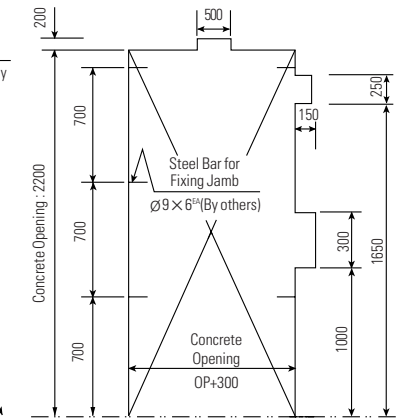

JP200 Type (Optional)

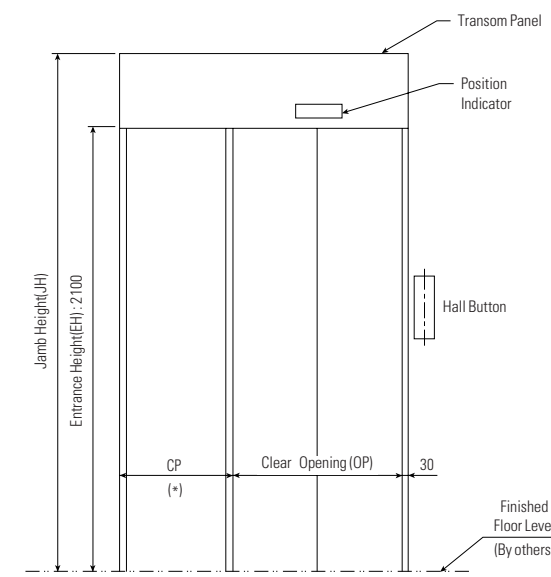
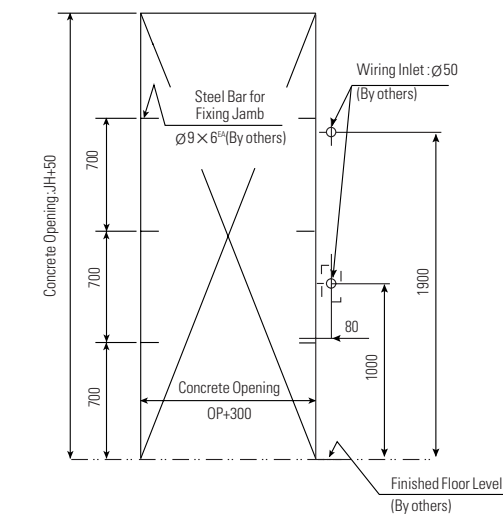
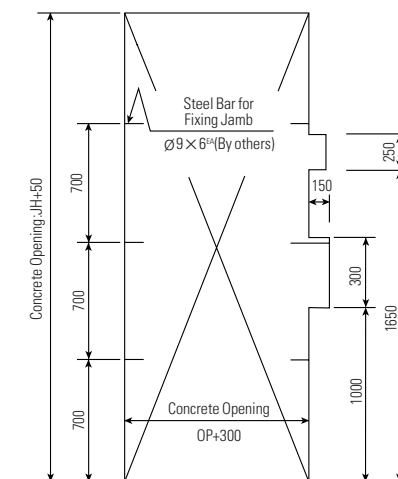

CP210 Type (Optional)

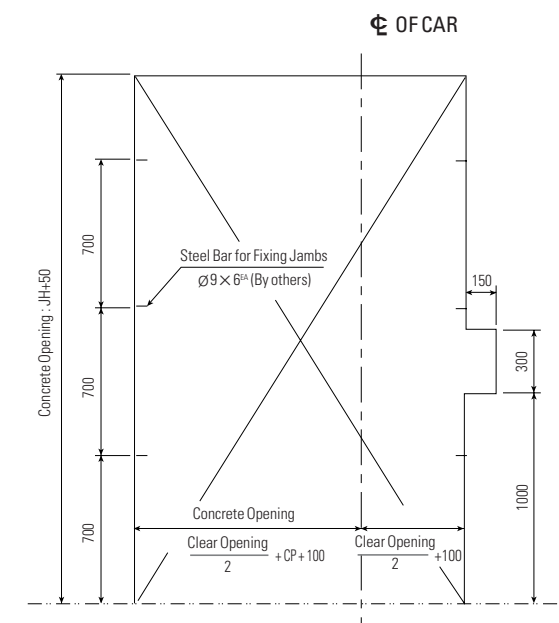

CP210 Type (Optional)

(Unit: mm)

Persons	Speed(m/min)	Width of Control Panel(CP)(*)
8-17	Under 105	530
	60	530
20, 24	90	630
	105	630

Typical Entrance Layouts – 2-Panel Center-Opening (CO) Layout

Plan of Entrance

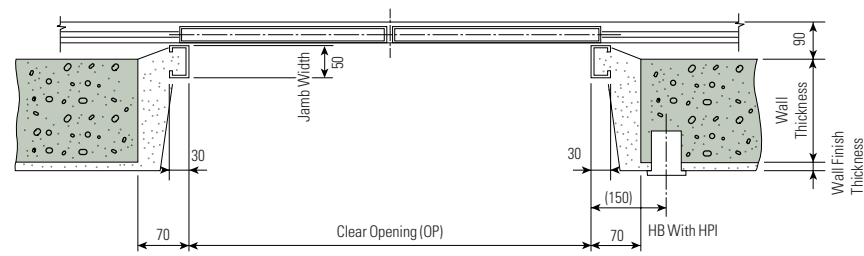

JP050 Type

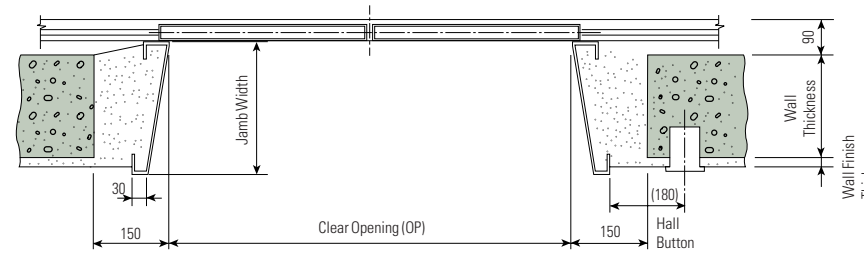

JP100, JP200 Type

Section Entrance

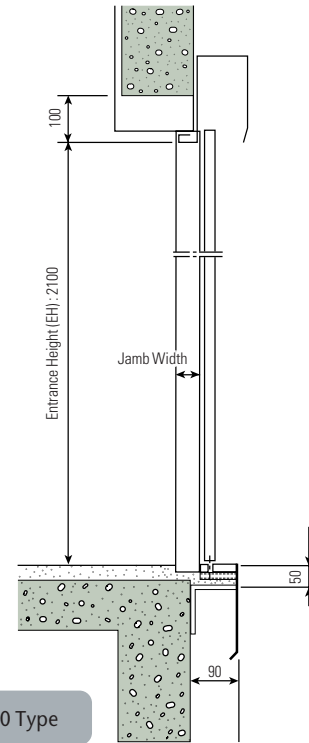

JP050 Type

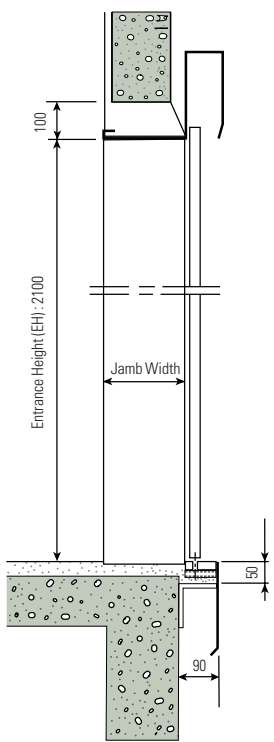

JP100 Type

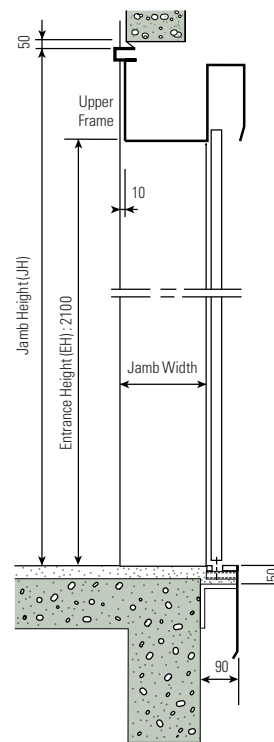

JP200 Type
(with upper frame)

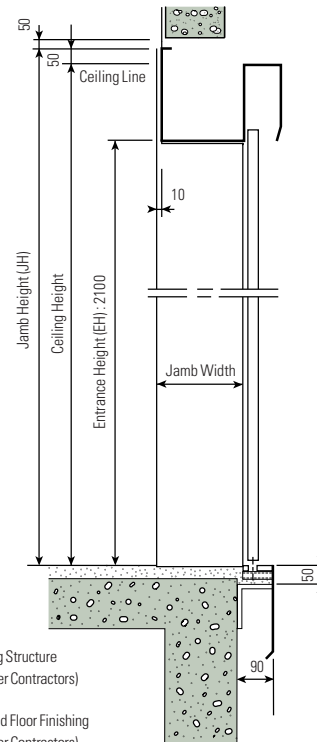

JP200 Type
(without upper frame)

Building Structure
(By Other Contractors)

Wall and Floor Finishing
(By Other Contractors)

Works To Be Done By Other Contractors

The following works are not included in the elevator contract, and shall be done by other contractors in accordance with the Hyundai Elevator's drawings and the applicable codes and regulations.

The reference rules shown are from ANSI A17.1 Code.

Building Work

Hoistway

- Clear, plumb hoistway with fire resistant hatch walls as required by the governing code. (Rule 100.1a)
- 75° bevel guards on all projections, recesses or setbacks over 50mm except on side used for loading or unloading. (Rule 100.6)
- Venting of the hoistway as required by the governing code or authority. (Rule 100.4)
- Supports for rail brackets at each floor, roof, and machine room. (Rule 200.9)
Maximum allowable vertical spacing of rail supports, without backing. (Rule 200.4 and 301.1)
Divider beams 100mm between hoistway at each floor and roof, for guide rail bracket supports. (Rule 200.4, 200.9 and 301.1)
- Recesses, supports and patching as required to accommodate hall button boxes, signal fixtures, etc.
- All barricades either outside elevator hoistways or between elevators inside hoistways are required.
- Dry pit reinforced to sustain normal vertical forces from rails and buffers. (Rule 106.1b and 109)
Consult Hyundai Elevator Company for rail forces and buffer impacts.
Where there is space below the pit floor which can be occupied, consult Hyundai Elevator Company for special requirements. (Rule 300.4)
Cylinder hole, casings under the pit as required and backfilling around the cylinder casings when direct plunger type is to be installed.
- Where access to the pit is by means of the lowest hoistway entrance, vertical iron ladder extending 1060mm minimum above sill of access door. (Rule 106.1d)
- Entrance walls and finished floor are not to be constructed until after door frames and sills are in place.
Door frames are to be anchored to walls and properly grouted in place to maintain legal fire rating.
- Sill supports 64mm minimum floor recesses full hoistway width for entrance sills, with grouting after sills are set in place.
- For application as indoor observation elevator, a minimum 3.6m high glass enclosure above bottom landing is recommended for safety.
For application as outdoor observation elevator, full height glass enclosure is required.

Machine Room

- Enclosed and protected machine room. (Rule 101.1)
- Access to the machine room and machinery space as required by the governing code or authority. (Rule 101.3)
- Reinforced concrete machine room floor slab or grating, as specified, which must not be placed over the hoistway until elevator machinery is set in position. (Rule 100.3 for Traction Elevator)
- Hoisting beams, trap doors and other means of access to machine room for maintenance and equipment removal purposes. (Rule 101.3d)
- Cable guards in the machine room or secondary level. (Rule 104.1)
- Supports for machine and sheave beams and reactions including wall pockets and patching after beams are set in place. (Rule 105.1 to 105.5)

Electrical Work

Hoistway

- Light outlet for each elevator, in center of hoistway (or in machine room) as indicated by Hyundai Elevator Company.
- Convenience outlet and light fixture in pit with switch located adjacent to the access door. (Rule 106.1e)
- Wiring and piping work of emergency bell, interphone, etc.
Outside the hoistway and the machine room.

Machine Room

- Lighting, convenience outlets, ventilation, heating of machine room, and machinery space. (Rule 101.5)
- Temperature should be maintained below 40°C with ventilating fan and/or air conditioner, if necessary, and humidity below 90%.
- A fused disconnect switch or circuit breaker for each elevator and light switch located per the governing code and where practicable located adjacent to the door of the machine room. (Rule 210.5 and 306.7)
- Feeder and branch wiring to the controller, including main-line switch and convenience outlets.
- Suitable power feeder and branch wiring circuits as required for elevators with power operated doors, including disconnect switch or circuit breaker.

Emergency Provisions

- Elevator fireman's and other emergency services wiring and interconnections to automatic sprinkler systems or heat and smoke sensing devices furnished by others and installed to terminal points on the elevator controllers.
- When emergency power operation of elevators is required, the electrical contractor should coordinate with Hyundai Elevator Company or local distributor for operation requirements.
- Elevator fireman's and other emergency service requirements may differ from each country. Consult Hyundai Elevator Company or local distributor for other local requirements.
- When provisions for earthquake protection are required, consult Hyundai Elevator Company for special requirements.

Heat Emission of Machine Room

$$Q(\text{Kcal/H}) = W \times V \times F \times N$$

W: Capacity (kg) N: Number of cars

V: Speed (m/min)

F: Factor (1/40: VWF)

Electric Power Requirements (By others)

VVVF (50/60Hz, 380V)

Persons (kg)	Speed (m/min)	Motor (kW)	MCCB(A)		Power(KVA)		Cable (mm ²)		Earth (mm ²)	
			1Car	2Cars	1Car	2Cars	1Car	2Cars	1Car	2Cars
6/450	60	5.5 (2.8)	20 (20)	30 (20)	4 (3)	7 (5)	4 (4)	6 (4)	4 (6)	4 (6)
	90	7.5 (4.2)	20 (20)	30 (40)	6 (4)	10 (8)	4 (4)	6 (10)	4 (6)	6 (6)
	105	7.5 (4.9)	20 (20)	40 (40)	7 (5)	12 (9)	4 (4)	10 (10)	4 (6)	6 (6)
8/550	60	5.5 (3.4)	20 (20)	30 (20)	5 (4)	9 (6)	4 (4)	6 (4)	4 (6)	4 (6)
	90	7.5 (5.1)	20 (20)	30 (40)	7 (5)	13 (10)	4 (4)	6 (10)	4 (6)	4 (6)
	105	11 (5.9)	30 (20)	50 (40)	8 (6)	15 (11)	6 (4)	16 (10)	4 (6)	6 (6)
9/600	60	5.5 (3.7)	20 (20)	30 (30)	5 (4)	9 (7)	4 (4)	6 (6)	4 (6)	4 (6)
	90	11 (5.6)	30 (20)	50 (40)	8 (6)	14 (11)	6 (4)	16 (10)	4 (6)	6 (10)
	105	11 (6.5)	30 (20)	50 (40)	9 (7)	16 (12)	6 (4)	16 (10)	4 (6)	6 (10)
10/700	60	7.5 (4.3)	20 (20)	40 (30)	6 (5)	11 (8)	4 (4)	10 (6)	4 (6)	6 (6)
	90	11 (6.5)	30 (20)	50 (40)	9 (7)	16 (12)	6 (4)	16 (10)	4 (6)	6 (6)
	105	11 (7.6)	30 (20)	60 (40)	11 (9)	19 (14)	6 (4)	16 (10)	4 (6)	10 (6)
11/750	60	7.5 (4.6)	20 (20)	40 (30)	6 (5)	12 (9)	4 (4)	10 (6)	4 (6)	6 (6)
	90	11 (6.9)	30 (20)	50 (40)	10 (7)	17 (13)	6 (4)	16 (10)	4 (6)	6 (10)
	105	11 (8.1)	30 (30)	60 (50)	11 (9)	20 (15)	10 (6)	16 (16)	4 (6)	10 (10)
	120	[9.2]	[30]	[50]	[10]	[18]	[6]	[16]	[6]	[10]
13/900	60	11 (5.6)	30 (20)	50 (30)	8 (6)	14 (11)	6 (4)	10 (6)	4 (6)	6 (6)
	90	15 (8.3)	40 (30)	60 (50)	12 (9)	21 (16)	10 (6)	16 (16)	6 (6)	10 (10)
	105	15 (9.7)	40 (30)	75 (50)	14 (10)	24 (18)	10 (6)	25 (16)	6 (6)	10 (10)
	120	[11.1]	[30]	[60]	[12]	[21]	[6]	[16]	[6]	[10]
	150	[13.8]	[50]	[100]	[15]	[28]	[10]	[25]	[6]	[16]
15/1000	60	11 (6.2)	30 (20)	50 (40)	9 (7)	15 (12)	6 (4)	16 (10)	4 (6)	6 (10)
	90	15 (9.2)	40 (30)	75 (50)	13 (10)	23 (18)	10 (6)	25 (16)	6 (6)	10 (10)
	105	15 (10.8)	40 (30)	75 (60)	15 (11)	27 (20)	10 (6)	25 (16)	6 (6)	10 (10)
	120	[12.3]	[40]	[75]	[13]	[23]	[10]	[25]	[6]	[16]
	150	[15.4]	[50]	[100]	[17]	[31]	[10]	[25]	[6]	[16]
17/1150	60	11 (7.1)	30 (20)	50 (40)	10 (8)	18 (13)	6 (4)	16 (10)	4 (6)	6 (10)
	90	15 (10.6)	40 (30)	75 (60)	15 (11)	27 (20)	10 (6)	25 (16)	6 (6)	10 (10)
	105	18.5 (12.4)	50 (30)	100 (60)	17 (13)	31 (23)	16 (6)	35 (16)	6 (6)	10 (16)
	120	[14.1]	[40]	[75]	[15]	[27]	[10]	[25]	[6]	[16]
	150	[17.7]	[60]	[100]	[20]	[35]	[10]	[25]	[6]	[16]
20/1350	60	15 (8.3)	30 (20)	60 (40)	12 (9)	21 (16)	10 (4)	16 (10)	6 (6)	6 (6)
	90	18.5 (12.5)	50 (40)	100 (75)	17 (13)	31 (24)	16 (10)	25 (25)	6 (6)	10 (10)
	105	22 (14.5)	50 (40)	100 (75)	20 (15)	37 (28)	16 (10)	35 (25)	6 (6)	10 (10)
	120	[16.6]	[40]	[100]	[17]	[31]	[10]	[25]	[6]	[10]
	150	[20.7]	[75]	[125]	[23]	[41]	[16]	[35]	[10]	[25]
24/1600	60	15 (9.9)	40 (30)	75 (50)	14 (10)	25 (19)	10 (6)	25 (16)	6 (6)	10 (6)
	90	22 (14.8)	50 (50)	100 (75)	21 (16)	37 (28)	16 (10)	35 (25)	6 (6)	10 (10)
	105	22 (17.2)	60 (50)	125 (100)	24 (18)	43 (33)	16 (16)	35 (25)	10 (6)	16 (10)
	120	[19.7]	[50]	[100]	[21]	[37]	[16]	[25]	[6]	[10]
	150	[24.5]	[75]	[150]	[27]	[49]	[16]	[50]	[10]	[35]

Notes: 1. Above power feeder sizes are for the length of electric wire up to 50m from elevator machine room to power.
For the length being 50m or more, the following formular should be applied.
2. Above cable sizes are for copper wires inside electrometallic tubings.
Cable sizes(mm²) = $\frac{\text{Cable length(m)}}{50} \times \text{Size in the above(mm}^2\text{)}$

3. For power requirement of 3 cars or more, consult Hyundai.
4. Machine room temperature should be maintained below 40°C with ventilating fan and air conditioner, and humidity below 90%.
5. Data shown in () is applied to the Machine-Room-Less elevators and gearless elevators.

VVVF (50/60Hz, 220V)

Persons (kg)	Speed (m/min)	Motor (kW)	MCCB(A)		Power(KVA)		Cable (mm ²)		Earth (mm ²)	
			1Car	2Cars	1Car	2Cars	1Car	2Cars	1Car	2Cars
6/450	60	5.5 (2.8)	30 (20)	50 (40)	4.3 (3.3)	8 (6)	4 (4)	10 (6)	4 (4)	6 (6)
	90	7.5 (4.2)	30 (30)	60 (60)	6.4 (4.9)	12 (9)	6 (6)	16 (16)	4 (4)	10 (10)
	105	7.5 (4.9)	40 (30)	75 (60)	7.5 (5.7)	14 (10)	6 (6)	16 (16)	6 (4)	10 (10)
8/550	60	5.5 (3.4)	30 (20)	50 (40)	5.3 (4)	9 (7)	4 (4)	16 (6)	4 (4)	6 (6)
	90	7.5 (5.1)	40 (30)	75 (60)	7.9 (6)	14 (11)	6 (6)	25 (16)	6 (4)	10 (10)
	105	11 (5.9)	40 (30)	75 (60)	9.2 (7)	17 (13)	10 (6)	25 (16)	6 (4)	10 (10)
9/600	60	5.5 (3.7)	30 (20)	60 (40)	5.7 (4.4)	10 (8)	4 (4)	16 (10)	4 (4)	10 (6)
	90	11 (5.6)	40 (30)	75 (60)	8.6 (6.5)	15 (12)	10 (6)	25 (16)	6 (4)	10 (10)
	105	11 (6.5)	40 (30)	100 (60)	10 (7.6)	18 (14)	10 (6)	25 (16)	6 (6)	16 (10)
10/700	60	7.5 (4.3)	30 (20)	60 (40)	6.7 (5.1)	12 (9)	6 (4)	16 (10)	4 (4)	10 (6)
	90	11 (6.5)	40 (30)	100 (60)	10 (7.6)	18 (14)	10 (6)	25 (16)	6 (6)	16 (10)
	105	11 (7.6)	50 (40)	100 (75)	11.7 (8.8)	21 (16)	16 (6)	35 (25)	6 (6)	16 (10)
11/750	60	7.5 (4.6)	30 (30)	60 (50)	7.2 (5.4)	13 (10)	6 (4)	16 (10)	4 (4)	10 (6)
	90	11 (6.9)	50 (40)	100 (75)	10.7 (8.1)	19 (15)	10 (6)	35 (16)	6 (6)	16 (10)
	105	11 (8.1)	50 (40)	100 (75)	12.5 (9.5)	23 (17)	16 (10)	35 (25)	6 (6)	16 (10)
	120	[9.2]	[40]	[100]	[10.8]	[19]	[10]	[25]	[6]	[16]
13/900	60	11 (5.6)	40 (30)	75 (50)	8.6 (6.5)	15 (12)	10 (4)	25 (16)	6 (4)	10 (6)
	90	15 (8.3)	50 (40)	100 (75)	12.9 (9.7)	23 (18)	16 (10)	35 (25)	6 (6)	16 (10)
	105	15 (9.7)	60 (50)	125 (100)	15 (11.3)	27 (20)	16 (10)	50 (35)	10 (6)	25 (16)
	120	[11.1]	[50]	[100]	[13]	[23]	[16]	[35]	[6]	[16]
	150	[13.8]	[30]	[50]	[16.2]	[29]	[10]	[25]	[4]	[6]
15/1000	60	11 (6.2)	40 (30)	75 (60)	9.6 (7.2)	17 (13)	10 (6)	25 (16)	6 (4)	10 (10)
	90	15 (9.2)	60 (50)	125 (100)	14.3 (10.8)	26 (19)	16 (10)	35 (35)	10 (6)	25 (16)
	105	15 (10.8)	75 (50)	125 (100)	16.7 (12.6)	30 (23)	16 (16)	50 (35)	10 (6)	25 (16)
	120	[12.3]	[60]	[125]	[14.4]	[26]	[16]	[35]	[10]	[25]
	150	[15.4]	[30]	[50]	[18]	[32]	[16]	[35]	[4]	[6]
17/1150	60	11 (7.1)	50 (40)	100 (75)	11 (8.3)	20 (15)	10 (6)	35 (25)	6 (6)	16 (10)
	90	15 (10.6)	75 (50)	125 (100)	16.5 (12.4)	30 (22)	16 (10)	50 (25)	10 (6)	25 (16)
	105	18.5 (12.4)	75 (60)	150 (125)	19.2 (14.5)	35 (26)	25 (16)	70 (35)	10 (10)	25 (25)
	120	[14.1]	[70]	[150]	[16.5]	[30]	[25]	[50]	[10]	[25]
	150	[17.7]	[40]	[75]	[20.7]	[37]	[25]	[70]	[6]	[10]
20/1350	60	15 (8.3)	50 (40)	100 (75)	12.9 (9.7)	23 (18)	16 (10)	35 (25)	6 (6)	16 (10)
	90	18.5 (12.5)	75 (60)	150 (125)	19.3 (14.6)	35 (26)	25 (16)	70 (35)	10 (10)	25 (25)
	105	22 (14.5)	100 (60)	200 (125)	22.6 (17)	41 (31)	35 (16)	95 (35)	16 (10)	35 (25)
	120	[16.6]	[70]	[150]	[19.4]	[35]	[25]	[50]	[10]	[25]
	150	[20.7]	[50]	[100]	[24.2]	[44]	[25]	[95]	[6]	[16]
24/1600	60	15 (9.9)	60 (50)	125 (100)	15.3 (11.5)	28 (21)	16 (10)	50 (35)	10 (6)	25 (16)
	90	22 (14.8)	100 (70)	200 (125)	22.9 (17.3)	41 (31)	35 (16)	95 (35)	16 (10)	35 (25)
	105	22 (17.2)	100 (80)	200 (150)	26.8 (20.1)	48 (36)	35 (25)	95 (70)	16 (16)	35 (25)
	120	[19.7]	[80]	[175]	[23]	[41]	[35]	[95]	[16]	[35]
	150	[24.6]	[80]	[175]	[28.7]	[52]	[35]	[95]	[16]	[35]

Notes: 1. Above power feeder sizes are for the length of electric wire up to 50m from elevator machine room to power.
For the length being 50m or more, the following formular should be applied.
2. Above cable sizes are for copper wires inside electrometallic tubings.
Cable sizes(mm²) = $\frac{\text{Cable length(m)}}{50} \times \text{Size in the above(mm}^2\text{)}$

3. For power requirement of 3 cars or more, consult Hyundai.
4. Machine room temperature should be maintained below 40°C with ventilating fan and air conditioner, and humidity below 90%.
5. Data shown in () is applied to the Machine-Room-Less elevators and gearless elevators.